

CUTTING DATA RECOMMENDATIONS

Uddeholm Mirrax 40

Machining data are always dependent on the actual operation, the machine tool and the cutting data used. The machining data given in this datasheet are general guidelines that may have to be adjusted to the actual conditions of a specific machining operation.

Turning

Uddeholm MIRRAX 40

Turning 	Cemented carbide		HSS
	Roughing	Finishing	
Cutting speed, v_c (m/min)	80-130	130-180	10-15
Feed, f (mm/rev)	0,2-0,4	0,05-0,2	0,05-0,3
Depth of cut, a_p (mm)	2-4	0,5-2	0.5-3
Suitable grades	P20-P30 coated carbide	P10 coated carbide or cermet	-

Remarks:

1. Cutting fluid is recommended.
2. For turning with interrupted cut or face turning of large workpieces use a tougher cemented carbide grade.

Face milling

Face milling 	Cemented carbide	
	Roughing	Finishing
Cutting speed, v_c (m/min)	80-120	120-150
Feed, f_z (mm/tooth)	0,2-0,4	0,1-0,2
Depth of cut, a_p (mm)	2-5	-2
Suitable grades	P20-P40 coated carbide	P10-P20 coated carbide or cermet

Remarks:

1. Use a milling cutter with a positive-negative or positive-positive geometry.
2. Climb milling should generally be used.
3. Milling should generally be done without coolant.
If a high surface finish is required coolant may be used.
4. Cermets can be of use when finishing under stable conditions.

Square shoulder milling

Square shoulder milling with cemented carbide 	Cemented carbide		
	$a_e = 0.1 \times D$	$a_e = 0.5 \times D$	$a_e = 1 \times D$
Cutting speed, v_c (m/min)	80-120	70-110	60-100
Feed, f_z (mm/tooth)	0,25-0,3	0,15-0,2	0,1-0,15
Suitable grades	P15-P40 coated carbide		

Remarks:

1. Climb milling should generally be used.
2. Choose the cutter diameter (D) and the radial depth of cut (a_e) so that at least two cutting edges are engaged simultaneously.
3. If the machine tool power is inadequate for the data given reduce the depth of cut, but do not reduce the feed.

Slot milling Axial depth of cut, $a_p = \leq 1 \times D$		Cutter diameter (mm)				
		3 - 5	5 - 10	10 - 20	20 - 30	30 - 40
Uncoated HSS ¹⁻⁴⁾	Cutting speed, v_c (m/min)	8-12				
	Feed, f_z (mm/tooth)	0,01-0,03	0,03-0,04	0,04-0,05	0,05-0,06	0,06-0,09
Coated HSS ¹⁻⁴⁾	Cutting speed, v_c (m/min)	20-25				
	Feed, f_z (mm/tooth)	0,02-0,04	0,04-0,05	0,05-0,06	0,06-0,07	0,07-0,1
Solid cemented carbide ⁵⁻⁸⁾	Cutting speed, v_c (m/min)	60-100				
	Feed, f_z (mm/tooth)	0,006-0,01	0,01-0,02	0,02-0,04		
Indexable insert ⁶⁻⁸⁾ (cemented carbide inserts)	Cutting speed, v_c (m/min)	80-120				
	Feed, f_z (mm/tooth)			0,06-0,08	0,08-0,10	0,10-0,12
	Suitable grades	P15-P40 coated carbide				
Side milling Axial depth of cut, $a_p = \leq 1.5 \times D$		For side milling the same cutting speed as for slot milling can be used, but the feeds must be adjusted in order to obtain a suitable average chip thickness.				

Correction factor for side milling

Divide the cutter diameter with the radial depth of cut. See in the chart below which correction factor, C_f , this corresponds to, and multiply the chosen feed in the table for slot milling with this factor.

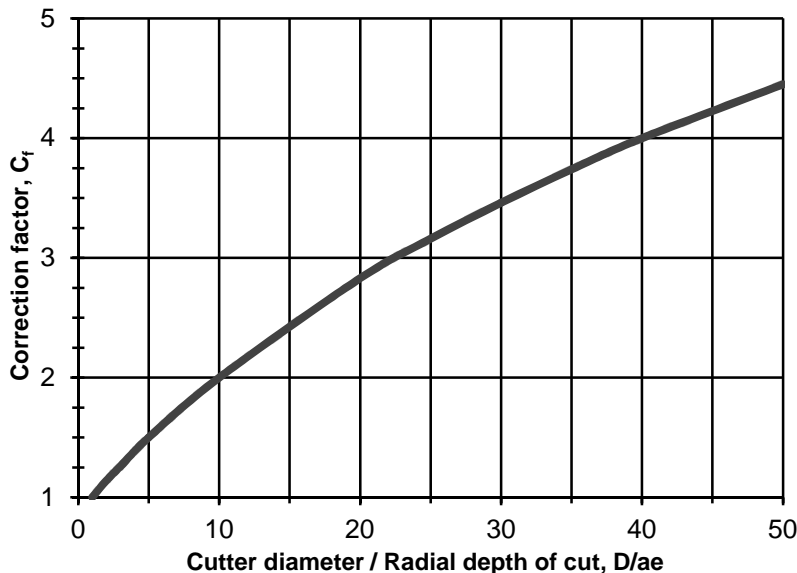

Example:

Tool:
CC insert

Cutter diameter:
 $D = 40 \text{ mm}$

Radial depth of cut:
 $a_e = 2 \text{ mm}$

$$D/a_e = 40/2 = 20$$

Feed acc. to table slot milling = 0.11 mm/tooth

Correction factor acc. to chart: $C_f = 2.8$

Feed for side milling:

$$f_z = 2.8 \times 0.11 = 0.31 \text{ mm/tooth}$$

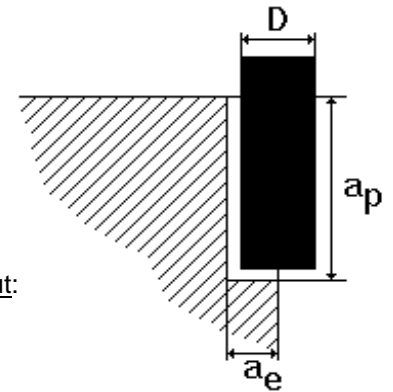

Remarks: (slot and side milling)

1. Climb milling is generally recommended.
2. Use a cutter with chipbreaker when side milling with radial depths of cut, $a_e > 0.3 \times D$.
3. When side milling with small radial depths of cut (a_e) the cutting speed can be increased by up to 15%.
4. Use liberal amounts of cutting fluid.
5. It is recommended to use a TiCN coated cutter when milling with solid cemented carbide tools.
The axial depth of cut should not exceed the cutter diameter when slot milling.
6. Climb milling is generally recommended.
7. When side milling with small radial depths of cut (a_e) the cutting speed can be increased by up to 30%.
8. The radial run-out, at the cutting edges, must be small and not exceed 0.03 mm.

Rough milling with round carbide inserts		Diameter of cutter, D (mm)				
		<20	21-30	31-40	41-50	>50
Axial depth of cut, $a_p = 0,2 \times D_i$	Cutting speed v_c (m/min)	100-120				
	Feed f_z (mm/tooth)	-0,18	0,19-0,21	0,22-0,24	0,25-0,27	0,28-
Axial depth of cut, $a_p = 0,15 \times D_i$	Cutting speed v_c (m/min)	120-140				
	Feed f_z (mm/tooth)	-0,2	0,21-0,23	0,24-0,26	0,27-0,29	0,3-
Axial depth of cut, $a_p = 0,1 \times D_i$	Cutting speed v_c (m/min)	140-160				
	Feed f_z (mm/tooth)	-0,23	0,24-0,26	0,27-0,29	0,3-0,32	0,33-
Axial depth of cut, $a_p = 0,05 \times D_i$	Cutting speed v_c (m/min)	160-180				
	Feed f_z (mm/tooth)	-0,31	0,32-0,34	0,35-0,37	0,38-0,4	0,41-

D_i = diameter of the insert

Rough milling with high feed cutters		Diameter of cutter, D (mm)				
		<20	21-30	31-40	41-50	>50
Axial depth of cut, $a_p = 100\% \text{ of max}^1$	Cutting speed v_c (m/min)	130-150				
	Feed f_z (mm/tooth)	-0,6	0,6-0,8	0,8-1,0	1,0-1,2	1,2-
Axial depth of cut, $a_p = 50\% \text{ of max}^1$	Cutting speed v_c (m/min)	150-170				
	Feed f_z (mm/tooth)	-0,8	0,8-1,0	1,0-1,2	1,2-1,4	1,4-

¹⁾ per centage of maximum depth of cut allowed (according to milling tool supplier)

Semi finishing and finishing milling with ballnose cutters		Diameter of cutter, D (mm)				
		<6	6-8	8-10	10-12	>12
Semi finishing Axial depth of cut, $a_p = 5\% \text{ of } D (\text{Ø cutter})$	Cutting speed v_c (m/min)	140-180				
	Feed f_z (mm/tooth)	-0,14	0,14-0,18	0,18-0,22	0,22-0,26	0,26-
Finishing Axial depth of cut, $a_p = 2\% \text{ of } D (\text{Ø cutter})$	Cutting speed v_c (m/min)	180-220				
	Feed f_z (mm/tooth)	-0,12	0,18-0,22	0,22-0,26	0,26-0,28	0,28-

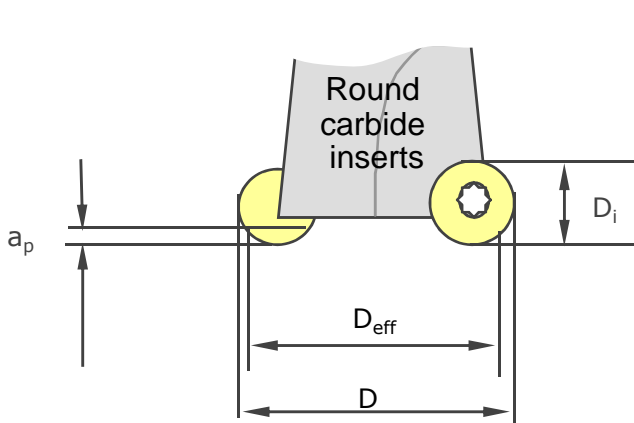

$$D_{eff} = 2 \cdot \sqrt{ap(D_i - ap)} + D - D_i \text{ (mm)}$$

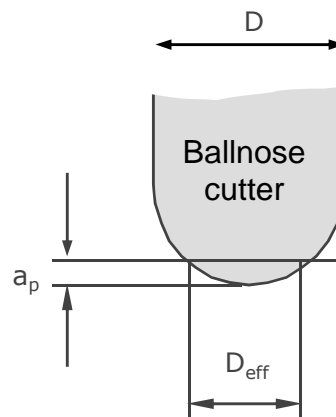

$$D_{eff} = 2 \cdot \sqrt{ap(D - ap)} \text{ (mm)}$$

Remarks cavity milling:

1. Down milling strategy is recommended
2. Recommended cutting speeds are at the effective cutter diameter (D_{eff})
3. Reduce the cutting speed and feed rate by 20% when using tool overhang $>5 \times D$
4. The radial depth of cut (a_e) should be maximum 70% of the effective cutter diameter (D_{eff})
5. A PVD coated carbide grade with sharp edge geometry is recommended

Drilling		Drill diameter (mm)				
		1 - 5	5 - 10	10 - 20	20 - 30	30 - 40
Uncoated HSS ¹⁻²⁾	Cutting speed, v_c (m/min)	10-12				
	Feed, f (mm/rev)	0,05-0,15	0,15-0,25	0,25-0,35	0,35-0,40	0,40-0,45
Coated HSS ¹⁻²⁾	Cutting speed, v_c (m/min)	16-18				
	Feed, f (mm/rev)	0,07-0,18	0,18-0,30	0,30-0,40	0,40-0,45	0,45-0,50
Indexable insert ³⁻⁴⁾ (cem. carbide inserts)	Cutting speed, v_c (m/min)				100-120	
	Feed, f (mm/rev)				0,05-0,10	0,10-0,15
Solid cemented carbide ⁵⁻⁸⁾	Cutting speed, v_c (m/min)	80-100				
	Feed, f (mm/rev)		0,08-0,10	0,10-0,20	0,20-0,30	0,30-0,35
Carbide tipped ⁵⁻⁸⁾	Cutting speed, v_c (m/min)	70-80				
	Feed, f (mm/rev)			0,15-0,25	0,25-0,35	0,35-0,40

Ud

Remarks:

1. The cutting fluid should be ample and directed at the tool.
2. When drilling with short "NC drills" the feed may be increased by up to 20%.
For extra long drills the feed must be decreased.
3. Use insert grades in the range of ISO P20-P30.
Under unstable conditions a tougher carbide grade should be used for the centre position.
4. Use a high cutting fluid pressure and flow rate for a good chip removal.
5. If machining with solid carbide or carbide tipped drills, a rigid set-up and stable working conditions are required.
6. The use of drills with internal cooling channels is recommended.
7. Use a cutting fluid concentration of 15-20 %.
8. For small drills "peck drilling" is needed for chip breaking

Tapping with HSS

Cutting speed, $v_c = 5-8$ m/min

Remarks:

1. Threading compound or cutting oil gives a longer tool life than emulsion.